

Technical data sheet



Product features

Food display island heated, glass ceramic GN 3-1/1 Wenge

Model	SAP Code	00012150
--------------	-----------------	----------



- Buffet type: BROWN - heated, glass-ceramic
- Device properties: Warmed
- Number of GN / EN: 3
- GN / EN size in device: GN 1/1
- Minimum device temperature [°C]: 60
- Maximum device temperature [°C]: 100

SAP Code	00012150	Loading	230 V / 1N - 50 Hz
Net Width [mm]	1169	Number of GN / EN	3
Net Depth [mm]	650	GN / EN size in device	GN 1/1
Net Height [mm]	1288	Minimum device temperature [°C]	60
Net Weight [kg]	78.00	Maximum device temperature [°C]	100
Power electric [kW]	0.855		

Technical data sheet



Technical drawing

Food display island heated, glass ceramic GN 3-1/1 Wenge

Model

SAP Code

00012150

A = ELECTRICAL CONNECTION
D = WATER DISCHARGE Ø14

GN	L
3/1	1169
4/1	1494
6/1	2144

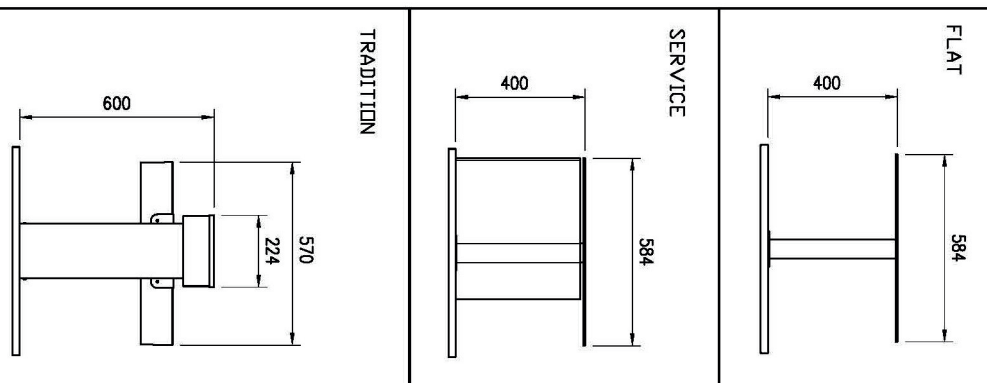
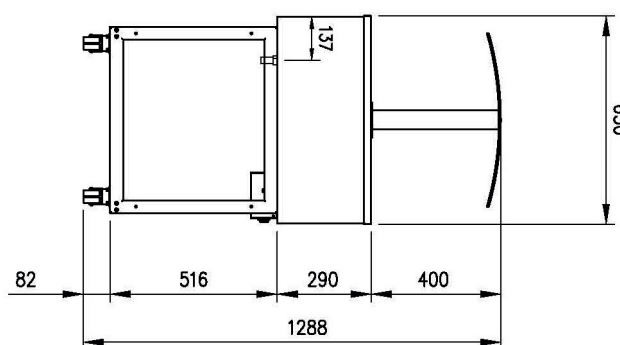
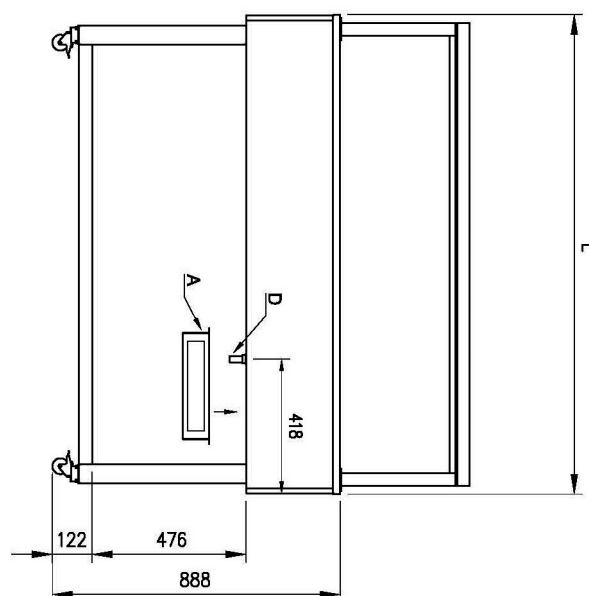
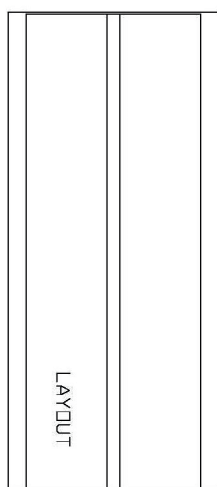

Technical data sheet



Product benefits

Food display island heated, glass ceramic GN 3-1/1 Wenge

Model

SAP Code

00012150

1

Glass ceramic plate

smooth hard surface
endurance

- easy maintenance
- long service life

2

No press

without sharp edges and corners

- higher hygienic safety
- time saving due to easy cleaning

3

All-stainless steel construction

harmless to health for contact with food
robustness

- long service life
- very easy to clean

4

Halogen lighting

heating from above

- more even heating of food
- greater hygienic safety

5

Travel wheels

portable buffet table

- greater flexibility in dispensing
- possibility of use at banquets
- easier and safer handling

6

Breath galley

galerka made of hygienic pexiglass with infrared heating

- hygienic food protection
- heating and lighting of food from above

Technical data sheet



Technical parameters

Food display island heated, glass ceramic GN 3-1/1 Wenge

Model

SAP Code

00012150

1. SAP Code:

00012150

2. Net Width [mm]:

1169

3. Net Depth [mm]:

650

4. Net Height [mm]:

1288

5. Net Weight [kg]:

78.00

6. Gross Width [mm]:

1230

7. Gross depth [mm]:

730

8. Gross Height [mm]:

1100

9. Gross Weight [kg]:

92.90

10. Device type:

Electric unit

11. Buffet type:

BROWN - heated, glass-ceramic

12. Device properties:

Warmed

13. Exterior color of the device:

Hemlock

14. Power electric [kW]:

0.855

15. Loading:

230 V / 1N - 50 Hz

16. Number of GN / EN:

3

17. GN / EN size in device:

GN 1/1

18. Minimum device temperature [°C]:

60

19. Maximum device temperature [°C]:

100

20. Interior lighting:

No